

The impact of feeders in closed-loop arrangement on harmonic distortion and power losses

K. Deželak¹, M. Rošer², R. Škof², T. Kastelic³ and G. Štumberger¹

¹ University of Maribor

Faculty of Electrical Engineering and Computer Science
Smetanova 17, 2000 Maribor (Slovenia)

Phone/Fax number:+386 2220 7180, e-mail: klemen.dezelak@uni-mb.si, gorazd.stumberger@uni-mb.si,

² Elektro Celje d.d.

Vrunčeva 2a, 3000 Celje (Slovenia)

Phone/Fax number:+386 3420 1000, e-mail: miran.rosler@elektro-celje.si, robert.skof@elektro-celje.si

³ Elektro Primorska d.d.

Erjavčeva 22, 5000 Nova Gorica (Slovenia)

Phone/Fax number:+386 5339 6700, e-mail: tomaz.kastelic@elektro-primorska.si

Abstract. This paper deals with the power losses and power quality in the medium-voltage distribution network considering feeders in the open- and closed-loop arrangements. The feeders in the open-loop arrangement are changed to the closed-loop arrangement with the aim to improve reliability of the power supply. Apart from that the power quality could be increased, while power losses could be decreased. In the case study the feeders supply loads, while in some cases loads are replaced with the renewable source of energy.

Key words

Medium-voltage distribution network, loop operation, losses, harmonic components.

1. Introduction

In the medium-voltage networks, the feeder in closed-loop arrangements are often used to improve voltage profiles in the feeders with distributed generation, to reduce the power losses caused by electric power transmission or to improve reliability and power quality of the power supply [1] - [5]. According to [2], the closed-loop arrangements of the feeders can be classified as the loops of the type I, type II and type III.

Paper [2] deals with the unbalance analysis and with the feasibility study for upgrading the feeders from radial open-loop arrangement to the closed-loop arrangement, while voltage characteristics in a distribution system with distributed generation are presented in [3]. Paper [4] investigates the possibility for reduction of line losses by

upgrading the distribution system from radial to closed-loop arrangement of feeders.

This work focuses on the loops of type II in medium-voltage distribution networks [1] and [2]. A special attention is dedicated to the power quality and power losses evaluation in distribution network with the feeders in the open- and closed-loop arrangement. In that way both feeders, that form the closed-loop, are sized in such a way that they can supply all loads on both feeders even when they are supplied only from the one side.

2. Medium-voltage distribution network

The discussed medium-voltage network is shown in Fig. 1. It consists of a substation RTP Krško with two 110 kV/20 kV transformers TR I and TR II. They supply two busbars marked by S1 and S2. Measurement points are denoted by M, LD stand for loads, SW is switch, while RS means the renewable source of energy. Voltages and currents are observed also at the high voltage (HV) side of the transformer and at the load LD1, respectively, while RS1 is the renewable source.

With the dynamic model of the discussed system, both, the total harmonic distortion and power losses are analysed, firstly for the open-loop and secondly for the closed-loop arrangement of feeders. The switch that is closing at specific time causes different arrangements of feeders. In that way the harmonic distortion for open- and closed-loop arrangement of feeders and power losses for

open-loop and closed-loop arrangement of feeders are analyzed.

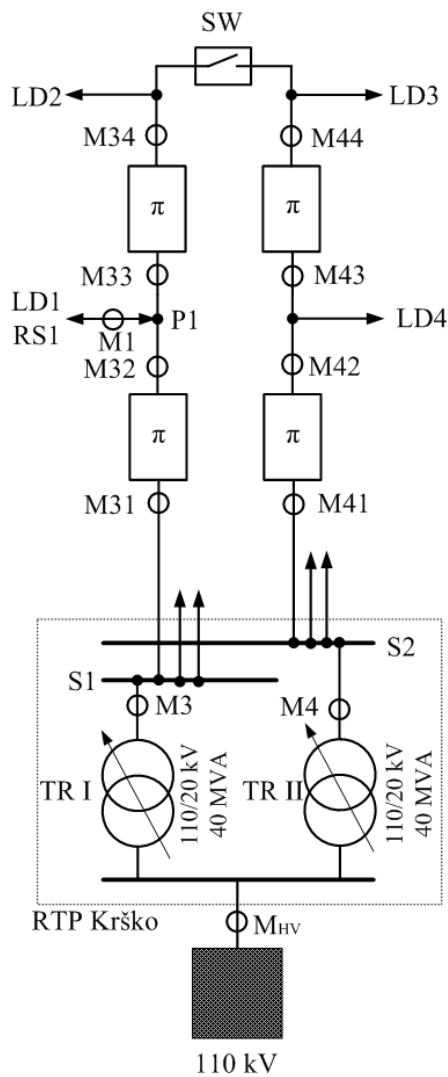

Fig. 1. Schematic presentation of discussed system

A. Harmonic distortion calculations

In this subsection the renewable source of energy RS1 is connected to grid at the point P1, while the load LD1 is equal to zero. In that sense Fig. 2 shows three powers in all three phases P_1 , P_2 and P_3 . The renewable source of energy included into the grid causes different higher order harmonic components at the inclusion point P1, while the feeder at S2 is loaded with linear loads. The switch SW was changed from the open to the closed position at time $t = 0.4$ s.

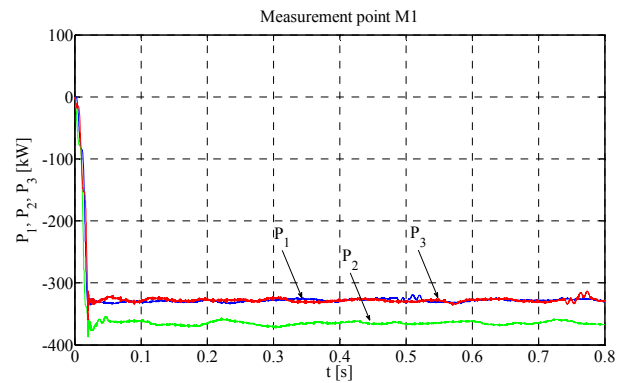

Fig. 2. Power at measurement point M1 (RS1)

The harmonic distortion in currents at the measurement points M31 and M41 are shown in Figs. 3 - 6 for the open-loop and closed-loop arrangements of feeders.

Table 1 shows numerical values of the root mean square (rms) values for voltages and currents in the first phase (U_{rms1} , I_{rms1}), power in the first phase P_1 and total harmonic distortion THD in currents and voltages in the first phase (THD_{i1} , THD_{u1}). All together the results are shown for five different measurement points (M3, M31, M4, M41 and M_{HV}).

Table I. - Numerical values of U , I , P and THD for the open- and closed-loop arrangement of feeders

Measurement		Open	Closed
M3	U_{rms1} [kV]	12,16365	12,18301
	THD_{u1} [%]	0,398998	0,139603
	I_{rms1} [A]	196,2274	256,5816
	THD_{i1} [%]	0,454397	0,140997
	P_1 [MW]	2,369586	3,12511
M31	U_{rms1} [kV]	12,16365	12,18301
	THD_{u1} [%]	0,398998	0,139603
	I_{rms1} [A]	13,57344	75,82212
	THD_{i1} [%]	8,430787	0,584337
	P_1 [MW]	0,155556	0,90288
M4	U_{rms1} [kV]	12,115	12,0893
	THD_{u1} [%]	0,043732	0,140557
	I_{rms1} [A]	413,5847	354,7476
	THD_{i1} [%]	0,011729	0,120934
	P_1 [MW]	4,990925	4,233001
M41	U_{rms1} [kV]	12,115	12,0893
	THD_{u1} [%]	0,043732	0,140557
	I_{rms1} [A]	57,06966	29,6493
	THD_{i1} [%]	0,140042	2,13721
	P_1 [MW]	0,682958	-0,05643
M_{HV}	U_{rms1} [kV]	59,7315	59,73349
	THD_{u1} [%]	0,04158	0,022193
	I_{rms1} [A]	170,8765	170,7658
	THD_{i1} [%]	0,103096	0,093804
	P_1 [MW]	10,03763	10,03613

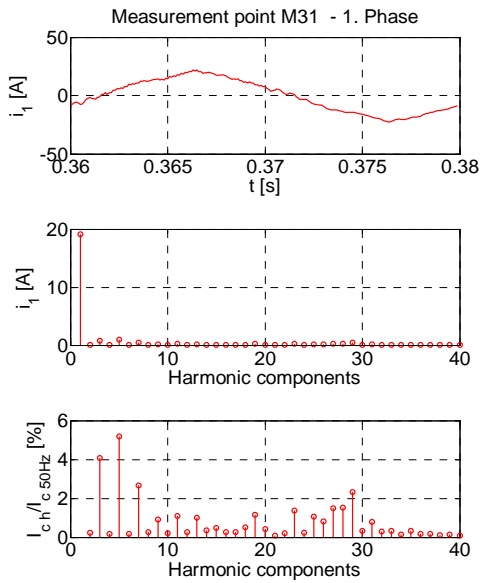

Fig. 3. Harmonic distortion at M31 for the open-loop arrangement of feeders

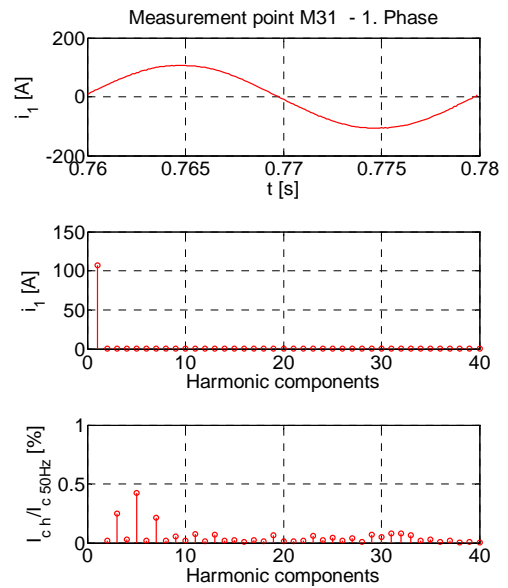

Fig. 5. Harmonic distortion at M31 for the closed-loop arrangement of feeders

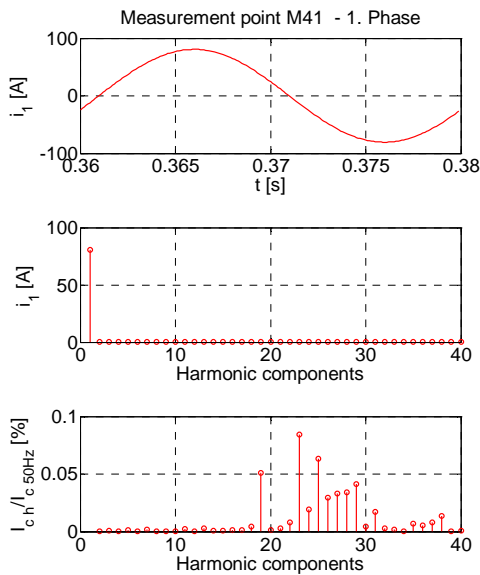

Fig. 4. Harmonic distortion at M41 for the open-loop arrangement of feeders

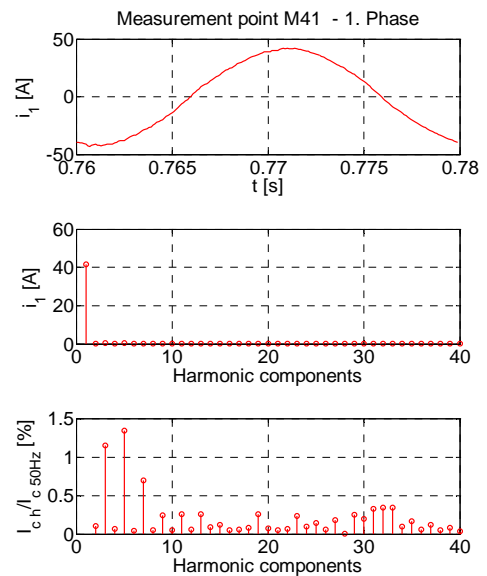

Fig. 6. Harmonic distortion at M41 for the closed-loop arrangement of feeders

The results presented show that both total harmonic distortions at S1 feeder (THD_{i3} , THD_{u3}), in the closed-loop arrangement, are improved. In that sense the current and voltage THDs decrease from approximately 0.4 % to 0.14 %. Even better improvement is reached in the current at the measurement point M31 that is closer to the point P1 (from 8,4 % to 0,58 %). At the other side S2 the total harmonic distortions are increased from approximately 0 % to 0.14 % for voltages and to 2.1 % for currents.

The results at the high voltage (M_{HV}) side, before and after the switch closing, show improvement in the total harmonic distortion for the closed-loop arrangements of feeders.

B. Power losses evaluations

In this subsection the power losses, on the medium voltage overhead power lines, are observed. Firstly for the open-loop and secondly for the closed-loop arrangement of feeders. Different arrangement of feeders is caused by the switch SW closing at $t = 0.5$ s. Within calculations the load LD1 is connected to the grid, while renewable source of energy RS1 is not connected. In that sense Fig. 7 shows the three powers in all three phases P_1 , P_2 and P_3 at the measurement point M1 (Fig. 1).

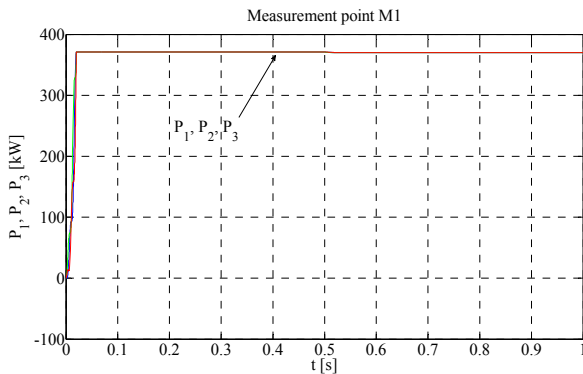

Fig. 7. Power at measurement point M1 (LD1)

Fig. 8 shows the total power losses ΔP (1) within the open-loop (from $t = 0$ s to $t = 0.5$ s) and closed-loop (from $t = 0.5$ s to $t = 1$ s) arrangement of feeders. In (1) the power losses at S1 feeder are denoted with ΔP_{S1} , while ΔP_{S2} stands for the power losses at S2 feeder.

$$\Delta P = \Delta P_{S1} + \Delta P_{S2} \quad (1)$$

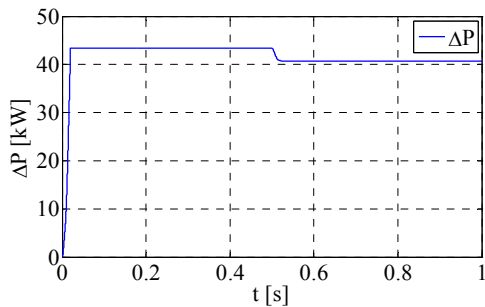

Fig. 8. Total power losses for open-loop and closed-loop arrangement of feeders

It is obvious that the total power losses are reduced (from 43 kW to 40 kW) after the changing operation from open- to closed-loop. The reason is that the power losses at S2 feeder ΔP_{S2} are decreased more than the power losses at S1 feeder ΔP_{S1} are increased (Fig. 9).

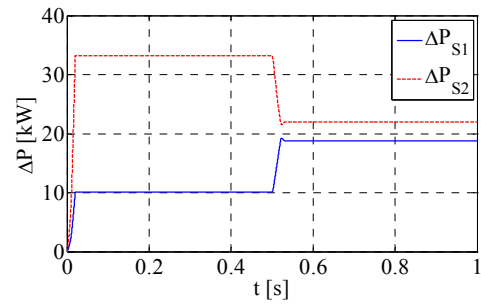

Fig. 9. Power losses for open-loop and closed-loop arrangement of feeders

3. Conclusion

The paper deals with the open- and closed-loop arrangement of feeders in the medium-voltage distribution network. The two connected feeders, are supplied from the two different transformers, located in the same substation, therefore they form the loop of type II. In the paper presented results show improvement in power quality and power losses in case of closed-loop arrangement of feeders. Additionally, the closed-loop arrangement can substantially improve the voltage profiles and the power supply reliability, however, before closed-loop arrangement of feeder can be implemented, problems related with proper realisation of protection should be solved.

References

- [1] G. Štumberger, K. Deželak, M. Rošer, R. Škof, T. Kastelic, Medium-voltage distribution feeders in open-loop and closed-loop arrangement, Proceedings of the International conference on renewable energies and power quality (ICREPQ' 12), 2012, Spain.
- [2] T. H. Chen, W. T. Huang, J. C. Gu, G. C. Pu, Y. H. Hsu, T. Y. Guo, Feasibility Study of Upgrading Primary Feeders from Radial and Open-Loop to Normally Closed-Loop Arrangement, IEEE Transactions on Power Systems, vol. 19, no. 3, pp. 1308 – 1316, 2004.
- [3] N. Okada, H. Kobayashi, K. Takigawa, M. Ichikawa, K. Kurokawa, Loop power flow control and voltage characteristics of distribution system for distributed generation including pv system, 3rd World Conference on Photovoltaic Energy Conversion, May 11-18, Osaka, Japan, pp. 2284-2287, 2003.
- [4] W. T. Huang, S. T. Chen, Line Loss Reduction by Distribution System Upgrading from Radial to Normally Closed-Loop Arrangement, Ninth International Conference on Hybrid Intelligent Systems, Washington, USA, vol. 3, pp. 334 – 339, 2009.
- [5] W. T. Huang, T. H. Chen, G. C. Pu, Y. F. Hsu, T. Y. Guo, Assessment of Upgrading Existing Primary Feeders from Radial to Normally Closed Loop Arrangement, IEEE Transmission and Distribution Conference and Exhibition, 3, 2002.