

Optimization with genetic algorithms of PVT system global efficiency

¹G.Fabbri ²M.Greppi ¹M.Lorenzini

¹D.I.E.N.C.A. Dipartimento di Ingegneria Energetica, Nucleare e del Controllo Ambientale Università degli Studi di Bologna, Viale Risorgimento 2, 40136 Bologna, Italy

E-mail address: giampietro.fabbri@unibo.it

E-mail address : marco.lorenzini@unibo.it

²Università di Bologna Seconda Facoltà di Ingegneria, via Fontanelle 40, 47100 Forlì

E-mail address: matteo.greppi2@unibo.it

Abstract

Photovoltaic (PV) solar panels generally produce electricity in the 6% to 12% efficiency range, the rest being dissipated in thermal losses. To recover this amount, hybrid photovoltaic thermal systems (PV/T) have been devised. These are devices that simultaneously convert solar energy into electricity and heat. A significant amount of research on PV/T collectors has been carried out over the last decade and water PV/T glazed flat plate collector systems turned out to be the most promising to develop (Zondag[1]). It is thus interesting to study the PV/T system as part of a closed loop single phase water CDU (coolant distribution unit) in laminar forced convection. In particular, the analysis was conducted on the optimal cooling performance of the thermal part, testing polynomial channel profiles of varying order (from zero to fourth) for channels of a real industrial module heat sink, under the following conditions: ideal flux of 1000 W/m² on one side, insulation on the opposite side, periodic conditions on the remaining sides, fully developed thermal and velocity profile in laminar flow of water. Through the use of a genetic algorithm, we have optimized the shape of the channel's sidewalls in terms of heat transfer maximization. In terms of Nusselt number, results show that fourth order profiles are the most efficient. When limits to allowable pressure loss and module weight are introduced, these bring generally to a lower efficiency of the system than the unconstrained case.

Key words

Fins, Genetic Algorithms, Multi Objective Optimization, Cooling, PVT systems

1. Introduction

Photovoltaic solar panels generally produce electricity in the 6% to 12% efficiency range, while most of the incident radiation is lost to the environment as thermal energy, whereas, in comparison, a solar thermal collector can operate in the 40% to 70% efficiency range. A lot of work has been done in the past to improve efficiency of PV panels, to reduce manufacturing costs and to integrate PV panels into walls and roofs of buildings. On the contrary, very little effort has been devoted in the past decades to the recovery of the dissipated thermal energy. By integrating the PV modules into a system designed to collect the heat lost to the environment, a solar cogeneration system is possible which holds enormous potential for improving the cost-benefits ratio of PV integrated roof and wall systems. Good results are expected also for stand alone applications.

Hybrid photovoltaic/thermal (PV/T) air-water collectors are devices that simultaneously convert solar energy into electricity and heat.

A significant amount of research on PV/T collectors has been carried out over the last decade. The review by Zondag [5] covers analytical and numerical models, simulation and experimental work, and qualitative evaluation of thermal/electrical output.

A PV/T collector typically consists of a PV module on the back of which an absorber plate (a heat extraction device) is attached. The purpose of the absorber plate is twofold. Firstly, to cool the PV module and thus improve its electrical performance (electrical efficiency losses amount to 0.4% for each degree of increase of cell temperature with reference to standard test conditions (STC): 25°C, $q''=1000\text{W/m}^2$) and secondly to collect the thermal energy produced, which would have otherwise been lost as heat to the environment.

As reported by Zondag et al. [1] the electrical and the thermal performance of PV/T collectors is lower than that of separate PV panels and conventional thermal collectors.

However, they emphasized that two PV/T collectors together produce more energy per unit surface area than one PV panel and one thermal collector next to each other.

A lot of parameters affects PV/T performance (both electrical and thermal) such as covered versus uncovered PV/T collectors, optimum mass flow rate, absorber plate parameters (i.e. tube spacing, tube diameter, fin thickness), absorber to fluid thermal conductance and configuration design types. Based on an exergy and cost analysis, water PVT glazed flat plate collector system results the most promising to develop (Zondag [1]).

Moreover, in the last few decades, in the field of electronic components the request for power dissipation continued to increase rapidly following Moore's law (the number of transistor in a microprocessor would double every 18 to 24 months). Advanced air cooling solutions like heat pipes or high flow rate fans were developed to manage the heat load in CPU and GPU devices at the expense of significant increase in noise level, energy cost and weight. At last, new liquid cooling CDU (coolant distribution unit), after late 80's stopping, looked strategically to meet the combined high heat loads with low thermal resistance.

Thus, it seems interesting to improve the thermal efficiency of a PV/T system as part of a closed loop single phase water CDU in laminar forced convection.

To study this problem, a mathematical model for the heat sink is used which is able to analyze the thermal and fluid dynamical alterations induced by changes in the channel profile. To optimize the performance of the heat sink in terms of heat transfer to the fluid, a genetic algorithm is employed to maximize the equivalent Nusselt number Nu_e and compared effectiveness E_c under pressure and maximum material constraints. The velocity and temperature distributions in the channel's cross section under conditions of uniform, imposed heat flux at one wall, periodicity at two walls and insulation at the other are computed with the help of a finite element model (a global heat transfer coefficient is calculated). Fabbri [3] already proposed a genetic algorithm optimization for the thermal efficiency of a heat sink analyzing different profiles for its fins (asymmetrical and symmetrical longitudinal wavy fins). In 2009 Copiello and Fabbri [4] proposed a multi-objective genetic optimization of the heat transfer from longitudinal wavy fins. Regarding an industrial module dissipator with a reference internal profile, looking for better thermal efficiency, we have imposed an ideal flux of 1000 W/m^2 . By means of a genetic algorithm we optimize polynomial upper and lower channel profiles, which are polynomial in nature, whereas the side walls are straight.

2. The mathematical model

Let us consider a modular heat sink composed of a large number of identical ducts where a coolant fluid flows in laminar regime under the same conditions, as shown in Fig.1. A heat flux q'' is uniformly imposed on one surface of the heat sink, while the opposite is thermally insulated.

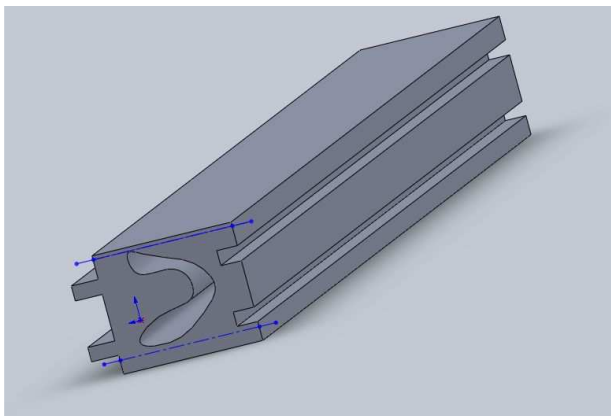

Fig. 1. Geometry of the heat sink characteristic module

The inner surface of the ducts is divided into four stretches, each corresponding to one side of the perimeter of its cross section. Of these, two are kept straight, and two (the side walls) can vary their shape according to a polynomial law. Externally, it is delimited by two flat surfaces and two sides having matching shapes which allow two adjacent ducts to be assembled together. In particular, on one side two trapezoidal protrusions are located, while on the opposite side are two trapezoidal cavities. In general, the duct wall must be sufficiently thick to ensure the mechanical consistence of the heat

sink. Moreover, on the side where the heat flux is imposed, it must be sufficiently thick to allow screws to be inserted to assemble the heat sink to the system to be cooled. Therefore, some limits must be imposed to the wall thickness on the four sides of the duct in our reference prototype (Fig.2).

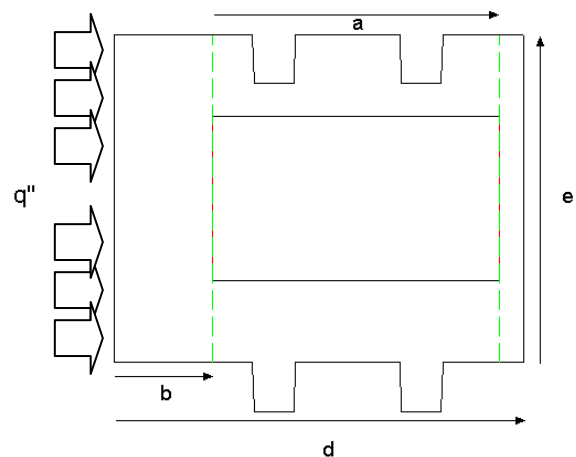

Fig 2. Reference prototype of the heat sink

Let us choose an orthogonal coordinate system, where the x axis is laid along the coolant flow direction and the y axis is orthogonal to the surface where the heat flux is imposed. Moreover, let a be the internal duct height in the y direction, b the thickness of the wall where the screws are inserted, d the external duct height, e the external duct width, $f_1(y)$ and $f_2(y)$ arbitrary functions which describe the profiles of the two wavy internal surfaces of the duct, and Ω_1 and Ω_2 the external contour line of the duct cross section on the side where fins and cavities are, respectively.

Since the dynamic and thermal behavior of the whole heat sink is periodic in the z direction, the analysis can be limited to a single duct. The following hypotheses are now introduced:

- the system is at steady state;
- velocity and temperature profiles are fully developed;
- fluid and solid properties are uniform and temperature independent ;
- viscous dissipation within the fluid is negligible;
- natural convection is negligible in comparison to the forced convection;

Under such conditions the coolant flow is described by the momentum equation, Eq.(1):

$$\frac{\partial^2 u}{\partial y^2} + \frac{\partial^2 u}{\partial z^2} = \frac{1}{\mu} \frac{\partial p}{\partial x} \quad (1)$$

where u is the fluid velocity, p the generalized pressure, which includes the gravitation potential, and μ the dynamic viscosity. Equation (1) must be integrated by imposing, as a boundary condition, that the velocity is zero on the contact surface between the fluid and the solid wall.

In the fluid, the temperature T_c must satisfy the following energy balance equation (2):

$$\frac{\partial^2 T_c}{\partial y^2} + \frac{\partial^2 T_c}{\partial z^2} = \frac{\rho c_p}{k_c} u \frac{\partial T_c}{\partial x} \quad (2)$$

ρ , c_p and k_c being the fluid density, specific heat and thermal conductivity, respectively. In the finned plate, the temperature must instead satisfy the energy equation for a solid, Eq. (3):

$$\frac{\partial^2 T_f}{\partial y^2} + \frac{\partial^2 T_f}{\partial z^2} = 0 \quad (3)$$

Where T_f is the temperature of the fin.

Equations (2) and (3) must be integrated by imposing boundary conditions corresponding to the following:

- the temperature and the heat flux in the normal direction at the interface between the solid and the fluid are identical;
- the heat flux in the normal direction is zero on the insulated flat surface and is equal to q'' on the opposite flat side of the duct

$$T_f[y, \omega_1(y)] = T_f[y, \omega_2(y)] \quad (4)$$

$$\left[\frac{\partial T_f}{\partial N} \right]_{[y, \omega_1(y)]} = \left[\frac{\partial T_f}{\partial N} \right]_{[y, \omega_2(y)]} \quad (5)$$

where functions $\omega_1(y)$ and $\omega_2(y)$ provide the value of the z coordinate in Ω_1 and Ω_2 respectively, and N is normal to the two lines. It also is also necessary to impose a temperature value in one point of the studied domain. Due to the complexity of the problem velocity and temperature distributions must be determined in a numerical way. The finite volume method described in [3] and [6] can also be conveniently applied to the investigated case. In these works parameters a , b , d , e and the profile functions $f_1(y)$ and $f_2(y)$ describe the geometry of the finned conduit. In the studied domain, z coordinate is equal to $f_1(y)$ on a lateral fin profile and to $2e - f_2(y)$ on the other. Dimensionless variables can be obtained by normalizing all geometrical parameters with d :

$$\alpha = \frac{a}{d}, \beta = \frac{b}{d}, \varepsilon = \frac{e}{d}, \eta = \frac{y}{d}$$

$$\varphi_1(\eta) = \frac{f_1(\eta d)}{d}, \varphi_2(\eta) = \frac{f_2(\eta d)}{d}$$

After determining the velocity and temperature distributions, bulk temperature, global heat transfer coefficient, the equivalent Nusselt number Nu_e , compared effectiveness E_c and normalized hydraulic resistance can be defined and calculated as in [3] and [6]. In particular, the equivalent Nusselt number, (Eq.6), is defined as the Nusselt number which would be obtained if the same heat flux removed by the modular heat sink were dissipated in a flat wall channel of the same height:

$$Nu_e = \frac{h \cdot 2d}{k_c} \quad (6)$$

$$\xi = \frac{-dp/dx}{\frac{(w_t/2e)}{12\mu}} \quad (7)$$

$$d^3$$

$$E_c = \frac{q''}{q''_r} \quad (8)$$

The compared effectiveness is defined as the ratio between the heat flux removed by the modular dissipator and that dissipated in a flat wall channel with the same hydraulic resistance (Eq.8), and the normalized hydraulic resistance ξ (Eq.7) is the ratio between the hydraulic resistance of the modular dissipator and that of a flat wall channel of the same height.

3. Geometry optimization

To optimize the geometry of the duct in order to maximize the equivalent Nusselt number and the compared effectiveness, a genetic algorithm has been used. A polynomial form has been assigned to the functions $f_1(y)$ and $f_2(y)$. These functions have then been represented by $n_1 + 1$ and $n_2 + 1$ parameters, consisting of the values of the functions in $n_1 + 1$ and $n_2 + 1$ equidistant points in the domain, n_1 and n_2 being the polynomial orders. Besides the Rp_{max} limits the condition of constrained finned plate volume has been taken into account imposing the average thickness σ_s . Moreover by imposing, for example, limits on the values of the derivatives of $f_1(y)$ and $f_2(y)$ at the end points (corresponding to constraints on the profile's curvature), the number of possible finned tube geometries can be reduced. After fixing the order of the polynomial function which describes the fin profile (from 1st to 4th order) a new profile is chosen as a prototype (Fig.2). The prototype is then reproduced with random mutations uniformly distributed between -10% and +10%, in order to compose an initial population of 10 samples (including the prototype).

For each sample the compared effectiveness is computed. The two samples with the best rank are selected and reproduced with the mutation rule described above. The new generation is evaluated, selected and reproduced in the same way. The process continues until there is no significant improvement in the compared effectiveness of the best sample or is reached a set number of simulations. The population dimension is chosen on the basis of the polynomial order. With low orders very numerous populations are not required to keep the algorithm from stopping in correspondence of a local maximum whereas larger populations are required for higher order profile functions. In the algorithm it's also possible to impose a local fin thickness (an upper and a lower limit to the fin profile by rescaling the parameter before evaluating the performances).

4. Results

Several tests using the GA have been carried out in order to find the geometries of the channel which maximize the Nusselt number Nu_e and E_c (compared effectiveness). We start from the unconstrained industrial module heat sink (Fig.3):

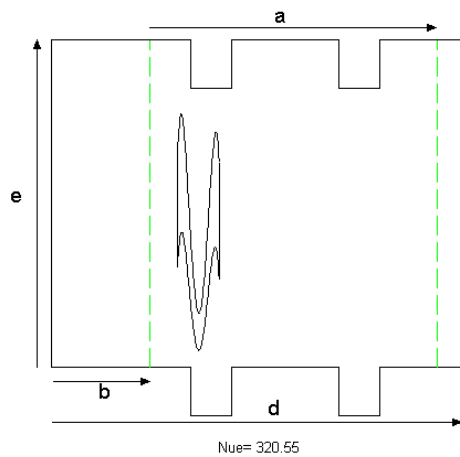

Fig. 3. Unconstrained module.

The module fitness rapidly increases with the channel squeezing towards the heated side but industrial manufacturing by extrusion would not be possible and R_p becomes too high.

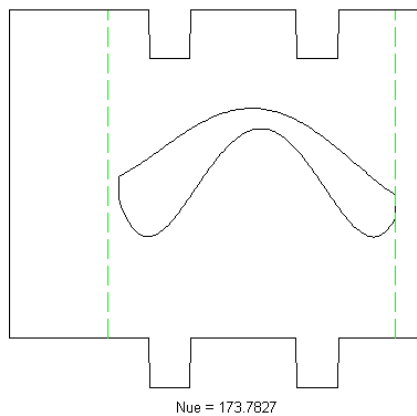

Fig.4 .4th order prototype- $\sigma_s/d=0.9-R_p$ unconstrained.

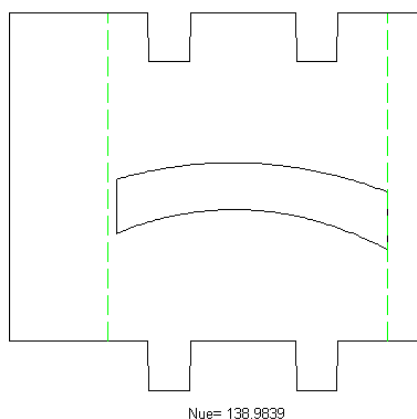

Fig.5 .2nd order prototype- $\sigma_s/d=0.9-R_p$ unconstrained.

Now we show (Figs.4,5) the best profile functions in terms of equivalent Nusselt number with second, third or fourth polynomial order with bonds only on σ_s/d (fixed volume).

Now for a more realistic analysis a constraint was imposed on R_p , namely 50, 100, 500, 1000, 2000 times the standard normalized reference value of a rectangular channel, Eq.(9):

$$R_{ps} = \frac{6\eta}{d^3} e. \quad (9)$$

which corresponds to the starting geometry. This has the consequence of decreasing the maximum cold plate efficiency. Stagnation occurs at the corners, which dampens the convective effect (Figs.6-10).

Lowering the maximum limit of the hydraulic resistance down $10R_{ps}$ we note that algorithm cannot operate for physical limits of the problem searching optimal thermal solutions

Fig.11 shows how σ_s/d ratio for different constraints and 4th polynomial order influence module fitness. Accepting for our profile high hydraulic resistance value up to $2000R_{ps}$, we can observe a monotonous curve until the σ_s/d ratio is equal to 0.85.

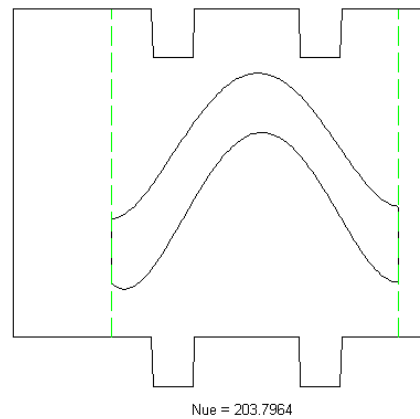

Fig. 6. 4th order prototype- $\sigma_s/d=0.85-2000 R_{ps}$

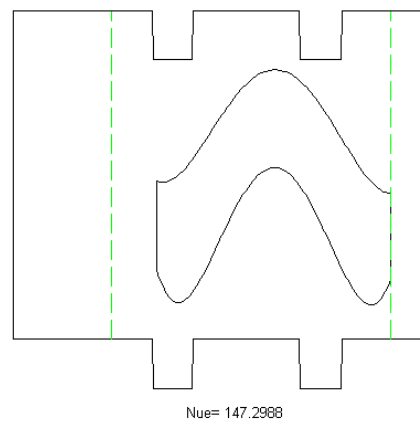

Fig.7.4th order prototype- $\sigma_s/d=0.85-1000 R_{ps}$.

After this value pressure losses are too high as the energy cost to pump the water inside the heat sink. With a different objective (maximize heat sink channel profile fitness with low pressure loss) lower σ_s/d ratio near 0.7 gives good result in terms of dissipating efficiency

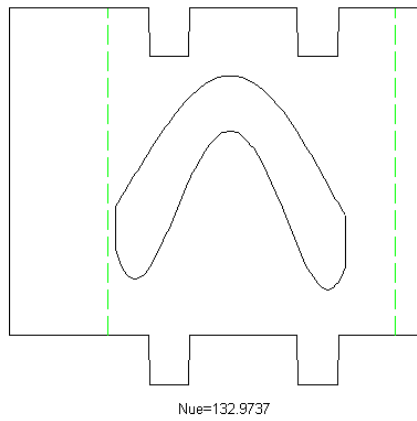

Fig 8. 4th order prototype- $\sigma_s/d=0.8-500 R_{ps}$.

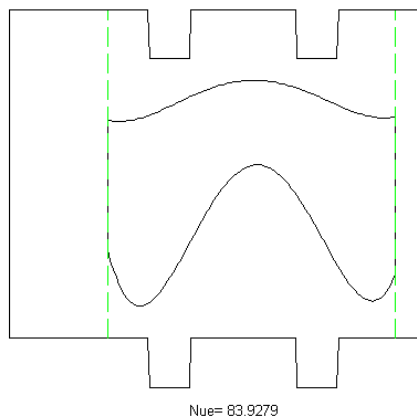

Fig..9. 4th order prototype- $\sigma_s/d=0.7-100 R_{ps}$.

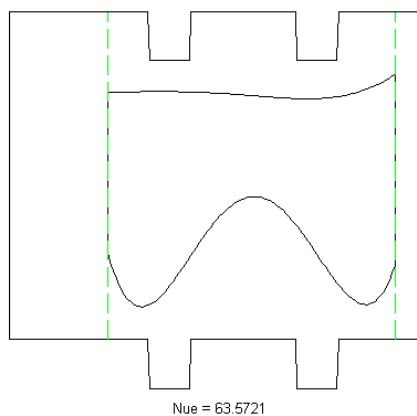

Fig. 10. 4th order prototype- $\sigma_s/d=0.65-50 R_{ps}$

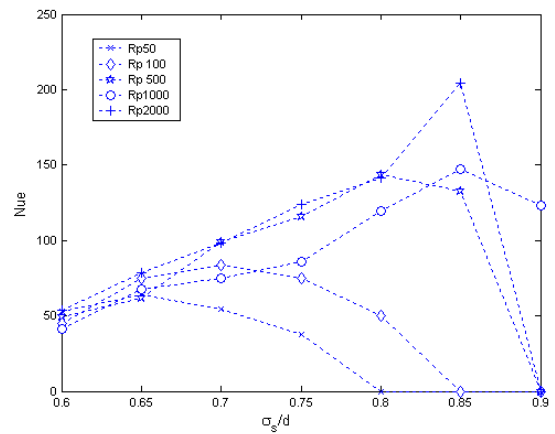

Fig. 11 - Nu_e as a function of σ_s/d for fourth order profiles

Now we show the ratio between compared efficiency Ec as a function of the hydraulic resistance of the channel for the 4th order profiles evaluated(Fig.12)

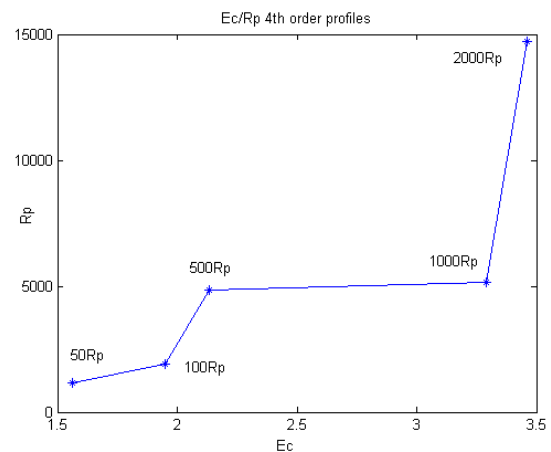

Fig. 12. Correlation $Ec-R_p$ 4th order profiles

It's interesting to underline that is not so linear the graph with the dependent variable, but for a particular value of R_p , Ec remains almost constant and then returns to increase (effect of profile's local convective thermal exchange).

5. References

- [1] H.A. Zondag, D.W. Vries, W.G.J. and A.A. Van Steenhoven, *Thermal and electrical yield of a hybrid-panel*, in: Proceedings of ISES Bi-annual Conference on CD-ROM, Jerusalem, (1999).
- [2] G.Dumont, Ph.Fontane Vive Roux, B.Righini, *Water-cooled electronics*, Nuclear Instruments and Methods in Physics Research A 440 (2000) 213-223
- [3] G. Fabbri *Optimum performances of longitudinal convective fins with symmetrical and asymmetrical profiles* International Journal of Heat and Fluid Flow 20 (1999) 634±641
- [4] Diego Copiello, Giampietro Fabbri, *Multi-objective genetic optimization of the heat transfer from longitudinal wavy fins*, International Journal of Heat and Mass transfer 52(2009) 1167-1176
- [5] H.A. Zondag, *Flat-plate PV-Thermal collectors and systems: A review* Renewable and Sustainable Energy Reviews 12 (2008) 891–959

[6] G.Fabbri, *Heat transfer optimization in internally finned tubes under laminar flow conditions* International Journal of Heat and Mass Transfer 41 (1998).. 1243-1253