

Battery Response Analyzer using a high current DC-DC converter as an electronic load

F. Ibañez, J.M. Echeverria, J. Vadillo, F.Martín and L.Fontán

Department of Electronic and Telecommunications
CEIT and Tecnun (University of Navarra)
Manuel de Lardizabal, 15, 20.018, San Sebastian (Spain)
Phone/Fax number:+0034 943 943 212800, e-mail: fmibanez@ceit.es

Abstract. This paper presents a battery response analyzer for high current levels. This system represents a very useful method to characterize simple battery and supercapacitor models, which commonly aid designers in the DC-DC converter development for electric vehicles (EV). A DC-DC converter is used to discharge batteries at a controlled current. The current is governed by a control unit which imposes a 100A pulse signal for the device under test (DUT). The response for the discharge pulse current is evaluated and then, a simple battery model is extracted. A complete low-cost test bench was developed in order to extract experimental data from batteries and super capacitors. Obtained measurements include high current pulse analysis and charge/discharge cycle to study the ageing of the device.

Key words

High Current, DC-DC Converter, Battery Response, Electronic Load, Battery Electrical Model.

1. Introduction

Energy storage devices should be studied in detail for the development of electrical systems such as electrical vehicles or uninterruptible power supplies (UPS). If the load current varies softly, the manufacturer datasheet and classical electrochemical models give enough information to estimate the voltage values of the batteries for electronic design purposes [1]. But, when the batteries have to deliver high current peaks, for example, while turning on an engine, a transient model [2], [3] is useful to predict the voltage drop and the number of current peaks that the battery can stand before reaching a minimum threshold voltage.

Furthermore, there exist many other battery models which are useful for studying different aspects of an electrochemical cell. Impedance-based models characterize internal chemical process; hence it is used in the design of the electrochemical cell. Each parameter is related to an internal chemical process. The method consists on an AC sweep at very low frequency, from 1 kHz down to less than 1 mHz [4].

A run-time model [5] correctly describes the self discharge and DC analysis such as: constant current or constant voltage charges, constant current discharges, and other tests with slowly variation in electrical magnitudes. However, it is not accurate for transient response. Finally, a mixture of several types of models can be implemented in order to achieve a general model for different processes [6].

The low-cost bench presented in this paper allows carrying out several measurements so that, an electrical model of a battery can be extracted. It also allows cycling batteries with discharge pulse patterns for particular ageing measurements.

The key block of the system is the electronic load (e-load) based on a DC-DC converter. It performs high current discharges and its cost is cheaper than a commercial e-load of these characteristics.

This bench is part of a project which objective is the study of different energy storage devices to be used in powering catenary-free tramways.

2. Objective

The main objective of this paper is to use a DC-DC converter as an electronic load for high current and low voltage applications [7].

The battery discharge current will be controlled by means of a reference signal generated by a software application.

In addition, the parameters for simple battery models will be extracted at different states of charge. In order to demonstrate the capabilities of the bench, a lead-acid battery will be tested.

3. Description of the system

High current battery discharges could be achieved using a low-value high-power resistor as load but it is not easy to manufacture this kind of devices. What is more, the resistors vary their value due to thermal effects. Consequently, the current could not be properly adjusted so, in order to stabilize it an electronic system is needed to improve the discharge control. A current-sink was implemented using a DC-DC converter. The main difference with the common use of a DC-DC converter, acting as a power supply, is that the control unit senses the input current instead of the output voltage.

The main diagram of the measurement bench [8] is shown in figure 1: the DUT (battery or supercapacitor stack), the power supply, the electronic load, the acquisition unit and the way they are connected can be observed on it. Wide lines imply high current paths.

The power supply is used to charge the battery in a constant current mode (CC) until it reaches a voltage limit. Then the supply switches to a constant voltage mode (CV) automatically.

The electronic load, as it was mentioned before, is used to discharge the battery. This load is controlled by a DSP. Both the DSP and the acquisition unit are connected to a computer.

A software application was developed to generate a discharge pattern to analyze the battery. This application allows the user to charge and discharge of the battery, so it can be cycled for measurement purposes. The software reads the measured values from the acquisition unit and generates a data file. It also generates a real-time graph showing the battery voltage and current.

The DC-DC converter [9] was designed to sink up to 120A in continuous mode with an input voltage up to 60V. The DC-DC topology is formed by a double full bridge with a transformer between them. It operates in a hard switching mode. The diagram of the converter is shown in figure 2. The system has 3 stages: a low voltage - high current full bridge (less than 60V), a high frequency (50 kHz) power

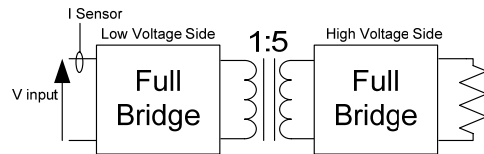

Fig. 2. Diagram of the converter. The power is transferred to a high voltage side in order to increase the resistor value.

transformer, with 1:5 ratio, and a high voltage - low current full bridge (100V to 250V) which is connected to the resistive load.

The sensor element is a LEM LF-205-S current transducer (closed loop Hall Effect sensor) which can work up to 200A at DC. The measured value is compared with a digital reference, which is governed by the software application. After that, the duty cycle is adjusted to reach the desired current value by means of PWM control.

The acquisition unit uses a sample rate of 4096S/s and a digital low pass filter to reduce the noise of the signal in order to improve the accuracy of the measurement.

Figure 3 shows a picture of the prototype. On the picture, the principal parts of the system can be distinguished: the tubular load resistor at the top of the bench, the DC-DC converter at the left, a switching circuitry (to select the battery) at the top right, two batteries (DUT's) in the bottom and outside the box at right the acquisition unit. The converter reduces the current of the battery increasing the voltage, so for the tubular resistor the current is five times lower.

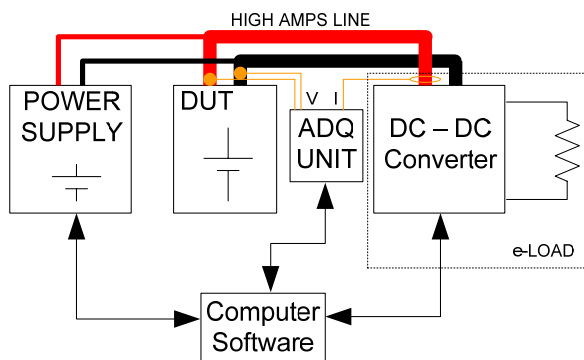

Fig. 1. Complete diagram of the measurement bench. Power supply, e-Load and the acquisition unit are governed by computer software which configures the bench, starts the measures and saves the results in a file.



Fig. 3. Picture of the whole system. The DC-DC converter is at left with its load in the top. In the middle there are two lead-acid batteries and at right the acquisition unit and the power supply can be seen.

The system is able to sense two batteries in the same test. Meanwhile one of the two batteries is being charged, the other one is being discharged and measured. This operating mode achieves an important reduction of time when many batteries have to be tested. The charge and discharge processes do not last the same, so gained time will not be the half obtained from two separated tests. The stage that implements this operation mode is the switching circuitry, which is also managed by the application software.

Results

The system was tested with a commercial automotive battery: 12V-43Ah lead-acid battery. Three types of measurements can be done in this test-bench. The first one is the transient analysis of the battery: the DUT is discharged with a step current of 100A. The voltage profile is measured and as a result, a simple electrical battery model is obtained.

The second experiment performs a pulsed discharge. This test aims to determine the number of current pulses the battery can tolerate until its voltage drops below a certain threshold (e.g. 10V).

The last analysis consists of a charge-discharge cycling [10], [11]. The batteries are charged in a CC-CV mode and discharged with a fixed number of pulses in order to test the ageing of the batteries under this specific condition. The charge and discharge times and the number of pulses depend on the end-user specifications.

A. Simple Model Extraction

A transient analysis of a battery is shown in figure 4. As far as the voltage curve is concerned, two voltage drops can be observed. Simultaneously to the current step, there exists an abrupt fall. After that, the voltage decreases slowly. The model will take into account the open-circuit voltage and the two drops.

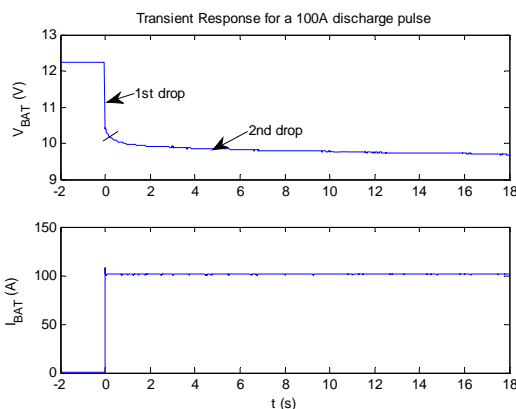

Fig. 4. Transient response for a 100A discharge pulse in a 12V-43Ah Lead-Acid battery.

First, the open-circuit voltage (VOC) is obtained. Then, when a 100A constant current is demanded from the battery, the first voltage down step is observed, which can be associated with a series resistance, R_0 . After this abrupt drop, the voltage decreases slowly. This part of the voltage profile can be modelled by two series RC tanks. This way, the complete circuit model is shown in figure 5. A measurement was done and the parameters of the model were extracted and listed in table I. These parameters were obtained by fitting the voltage profile curve. The values depend on the state of charge (SOC), temperature and age, so these parameters are only suitable for a particular condition. To improve this measurement a pulsed discharge should be carried out.

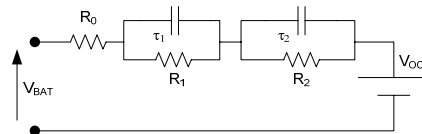

Fig. 5. Simple Battery Model evaluated using transient response.

Table I. - Battery Model Parameters

Parameters	Value	Unit
Series Resistance (R_0)	10	mOhm
Series Resistance of the tank 1 (R_1)	4.1	mOhm
Time Constant of the tank 1 (τ_1)	0.5	s
Series Resistance of the tank 2 (R_2)	3.2	mOhm
Time Constant of the tank 2 (τ_2)	30	s

B. Pulsed Discharge

The pulsed discharge process is used to determine how many current pulses a battery can tolerate. The parameters of this test are: current level, pulse width and pulse period.

Figure 6 shows a pulsed discharge of the same battery. Several pulses of 100A are used to discharge the battery in order to test how many pulses it can tolerate without dropping to a certain voltage level, for example 10V. It can be seen that this threshold level is reached in the last two pulses.

Data extracted from this test give information about the de-rating of the model parameters due to the state of charge (SOC) reduction. In the last graph of the figure it can be seen the increment of the deep of discharge (DOD) which is defined as $DOD = 1 - SOC$.

In order to demonstrate the capabilities of the bench, the de-rating curves of the battery were extracted. The battery was tested 10 times to obtain these curves, and then, the corresponding results were averaged. In figure 7, some parameters are shown.

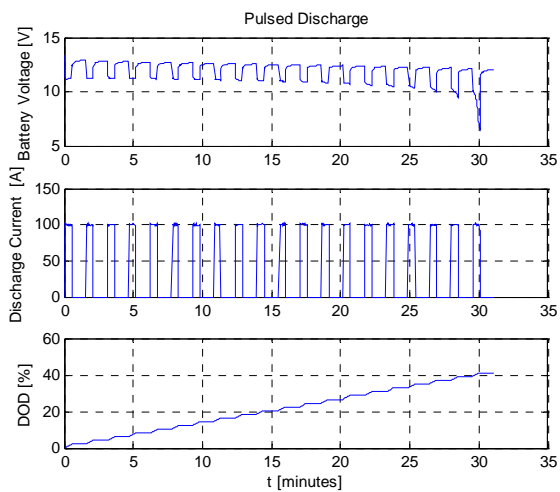
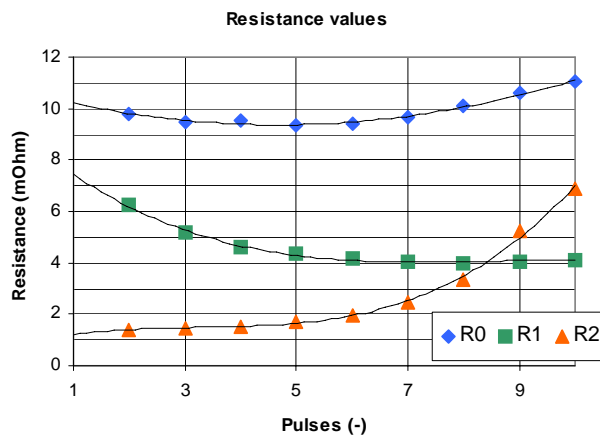
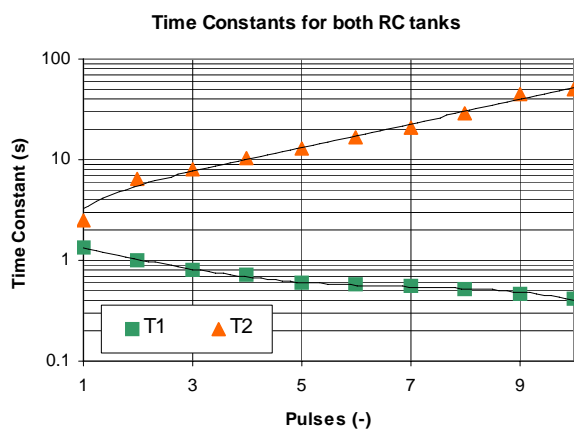

Fig. 6. Pulsed discharge of a battery. Voltage, current and DOD curves.



(a)



(b)

Fig. 7. De-rating of the parameters of the model in the successive pulses. (a) Resistance parameters: R_0 : series resistance, R_1 and R_2 : resistances of each RC tank. (b) Time constant for each RC tank.

As the test progresses, it can be noticed an increment in the difference between the time constants of the RC tanks. The second RC-tank takes more importance than the first one. The time constant for the second tank increases mainly due to the resistance variation. The same occurs in the first tank but in the opposite direction, i.e. the time constant is reduced mainly because of the change in the resistance.

C. Charge-Discharge Cycles

The system allows to charge-discharge batteries or supercapacitors. To illustrate this capability, a battery cycle is shown in figure 8. The voltage profile of the DUT and the discharge current are shown. The negative current corresponds to the charge current. Between two consecutive discharge processes the constant current and constant voltage periods can be observed.

Hence, this test makes possible to analyze the battery lifetime. In this case only a few cycles are shown to demonstrate the capabilities of the bench.

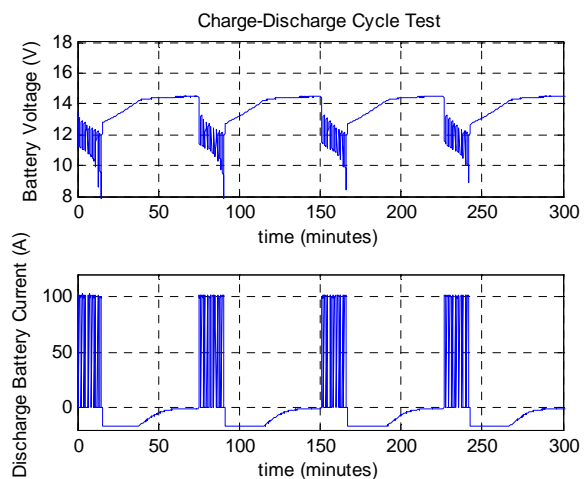

Fig. 8. Charge-Discharge Cycle test.

4. Conclusions

The test-bench operates for a wide range of input voltages, from 1V up to 60V. Therefore, different battery types can be analyzed, such as Ni-MH, Li-ion or lead-acid, as well as supercapacitors arrays. Furthermore the DUT may be a single cell or an array with a voltage up to 60V.

Electrical models of the DUT can be obtained for particular cases with this bench, as it was demonstrated in the results section. Models of any of the cells listed above can be extracted. As well as the transient model, the bench allows to discharge the DUT with a constant current pattern to achieve a DC model.

This system was developed to select a suitable energy storage device in a catenary-free tramway study. Hence, a discharge pulse pattern test has been included in the system to simulate an electric engine start up process. In addition, cycle ageing can be studied with this discharge profile. The measurements of several cell types will be obtained with this bench in order to select the correct technology.

Acknowledgements

The research leading to these results has received funding from the European Community's Framework Programme FP7/2007-2013 under Grant Agreement no. 241405. Consortium: CEIT, IMDEA-Energía, CEA-Leti, ApowerCap, Skeleton Technologies, NTUA. F. Ibañez hold the Amigos de la Universidad de Navarra grant.

References

- [1] David Linden, Handbook of batteries, 3rd ed., ISBN-13: 978-0071359788, 2001.
- [2] Ceraolo M., "New Dynamical Models of Lead-Acid Batteries" in IEEE Transactions on Power Systems, Vol. 15, No. 4, November 2000.
- [3] Salameh Z., Casacca M., Lynch W., "A mathematical Model for Lead-Acid Batteries" in IEEE Transactions on Energy Conversion, Vol. 7, No. 1, March 1992.
- [4] Buller S., Thele M et al., "Impedance-Based Simulation Models of Supercapacitors and Li-Ion Batteries for Power Electronic Applications" in IEEE Transactions on Industry Applications, May 2005.
- [5] S. C. Hageman., "Simple pspice models let you simulate common battery types," EDN, pp. 17-132, Oct. 1993.
- [6] Chen M. and Rincón-Mora G., "Accurate Electrical Battery Model Capable of Predicting Runtime and I-V" in IEEE transactions on Energy Conversion, Vol. 21, No. 2, June 2006, pp. 504-511.
- [7] Ouyang Huilin, Wang Gang, "The study of electronic load based on DSP" in IEEE Proceedings of Power Electronics Systems and Applications International Conference, 2004
- [8] Gonzalez, M. et al., "Universal test-bench for charging/discharging of Ni-Cd and Ni-MH batteries" Power Electronics Congress, 1994. Technical Proceedings, 3rd International, pp. 131-137, August 1994.
- [9] Ibañez F. et al., "5kw - 100 khz resonant converter prototype for a 40kw energy system unit on tramways" in IEEE ESARS International Conference, October 2010.
- [10] Yabuta, Matsushita K., Tsujikawa T., "Examination of the cycle life of valve regulated lead acid batteries" in Telecommunications Energy Conference, 2007. INTELEC 2007, 2007.
- [11] Buchmann, I., "Choosing a battery that will last. Cycle life of various battery systems" in Battery Conference on Applications and Advances, 1999.